

AFL020/CCT/**

20W IP65 Slim Design
CCT Selectable Floodlight



PRODUCT FEATURES

- IP65 Rating
- CCT Selectable (3000K/4000K/6000K)
- Push Terminals For Quick Install
- Built-In Junction Box
- Easy-Install Angled Bracket
- 360° Swivel Bracket
- Prismatic Toughened Glass
- Slimline Diecast Aluminium Body

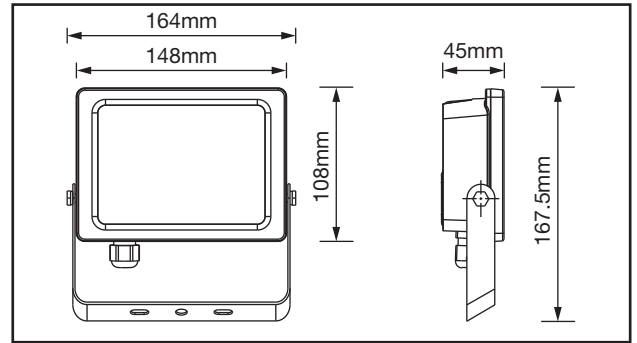

TECHNICAL SPECIFICATIONS

PRODUCT CODE	AFL020/CCT/**
Rated Power	20W
Housing Colour	Carbon Black / Polar White
Operating Voltage	220-240V
Frequency	50-60Hz
CRI	>80
Power Factor	>0.9
Beam Angle	120°
Lifetime To LM70	30,000 Hrs
Operating Temperature	-25°C-+40°C
SDCM	<6
Starting Time	0.5sec
Ingress Protection	IP65
LED Chip Type	SMD2835
Guarantee	2 Years
Useful Luminous Flux: 3000K / 4000K / 6000K	≤1570lm / ≤1722lm / ≤1569lm
CCT	3000K / 4000K / 6000K
Switching Cycles	≤15,000
Peak Intensity 3000K / 4000K / 6000K	703cd / 771cd / 701cd
Class	I



Carbon Black*
AFL020/CCT/BK



Polar White*
AFL020/CCT/WH



*Sold Separately