

## Dimensions

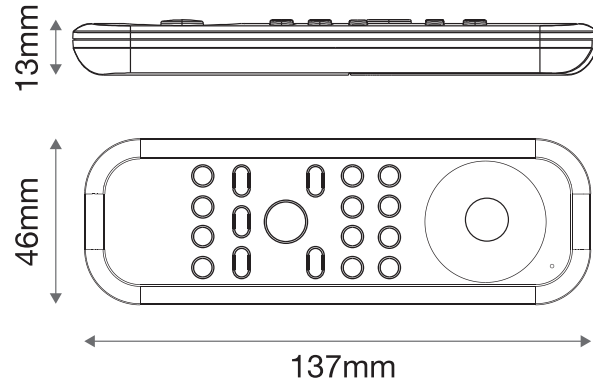

## Returns & Faulty Items

- If any problem is encountered during or after installation, please call the ALL LED technical department to get the problem resolved as soon as possible.
- Please do not just return the item to the outlet you purchased it from, as you are only entitled to a replacement or refund after the unit has undergone testing and the unit has been confirmed as having a manufacturing defect/fault. Your statutory rights are not affected.
- The manufacturer will not be deemed liable or held responsible for any damages caused by faults or manufacturing defects that may be present in any of its products or the misuse or incorrect installation of this device. Please refer to our troubleshooting guide for further information.
- All goods are supplied under the terms and conditions of All LED LTD, a copy of which may be obtained upon written request.



ALL LED LTD  
42 Sedgwick Road,  
Luton, LU4 9DT

www.allledgroup.com  
sales@allledgroup.com  
Tel: +44 (0)208 841 9000

The manufacturer will not be deemed liable or held responsible for any damages caused by faults or manufacturing defects that may be present in any of its products or the misuse or incorrect installation of this device. Your statutory rights are not affected.



Environmental Protection  
Waste electrical products should not be disposed of with household waste. Please recycle where facilities exist. Check with your Local Authority or retailer for recycling advice



PLEASE READ  
BEFORE USE!

## INSTALLATION GUIDE Smart Remote RGBW AiQ/RGBW/RMT

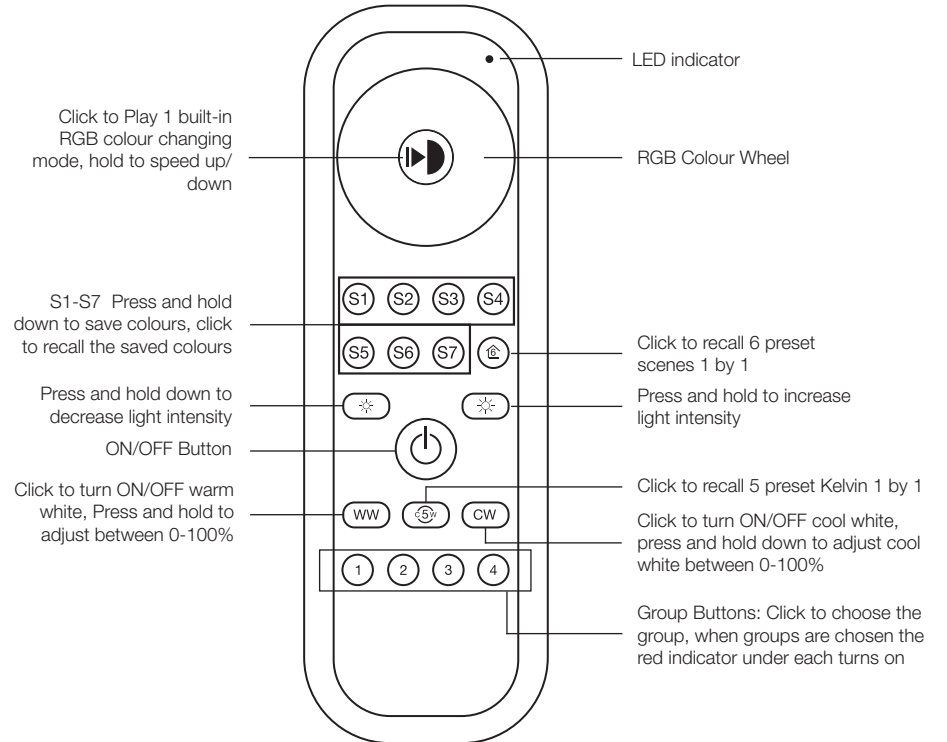

**Note:** This remote supports 4 groups for binding 30 lighting devices maximum. Also enables control of DIM, CCT, RGB, RGBW and RGB+CCT lighting devices.

### Product Data

Code	AiQ/RGB/RMT
Protocol	Zigbee 3.0
Operation Voltage	6V
Battery Type	CR2032 x 2
Transmission Frequency	2.4 GHz
Transmission Range (Free Field)	30 m
Dimension	137x45x13mm
Protection Grade	IP20

## Quick Install Guide

To be able to use a remote with your smart home hub and intelligent lighting follow (1 and 2).  
If you would like to use your remote directly with your intelligent lighting without a hub, follow instructions (2).

### 1) Connecting Your Remote to Smart Home Hub

**Note:** Before the first use, please remove the protective film on the battery.

**Step 1:** From Smart Home Hub App or Voice Control; Add a device or enter pairing mode. (30 Seconds)

**Step 2:** Press and Hold power button until LED indicator turns on.

**Step 3:** Quickly short press WW Button. LED indicator will flash. 20 Seconds until timeout. LED indicator blinks x3 quickly for successful pairing.

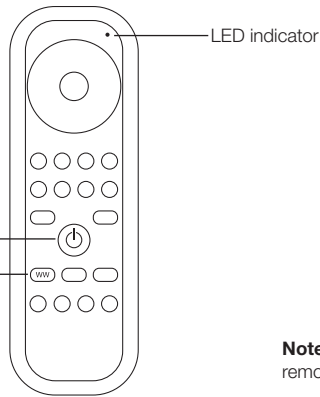

**Note:** If unsuccessful factory reset remote and try again.

### 2) Connecting Your Remote To Intelligent Lighting

**Step 1:** Set receiving device to Find and Bind mode. Lights will flash indicating Find and Bind mode active: Duration 3 minutes.

**Step 2:** Bring remote within 10cm of the Intelligent Lighting Device. 3 Minutes until timeout.

**Step 3:** Press and hold a group button. LED indicator will flash quickly and then blink x6 to indicate successful pairing.

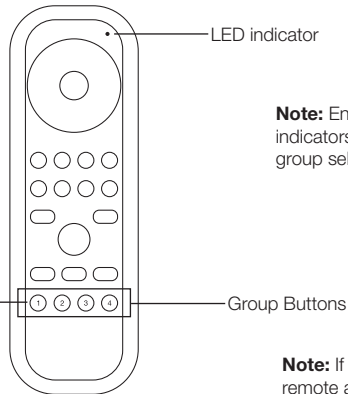

**Note:** Ensure group is selected, red indicators underneath will highlight group selected.

**Note:** If unsuccessful factory reset remote and try again.

## Factory Reset Remote

Remove the remote from previous Smart Home Hub if it has already been connected, otherwise pairing will fail.

**Step 1:** Press and Hold power button until LED indicator turns on.

**Step 2:** Quickly short press Power Button x5. LED indicator flashes x3 quickly to indicate successful reset.

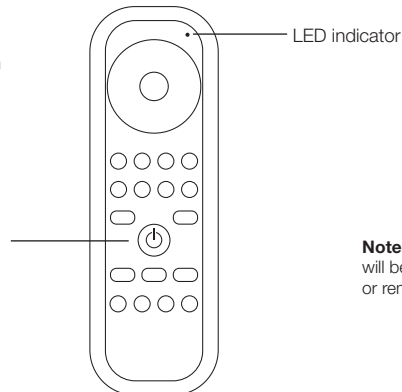

**Note:** All configuration parameters will be reset after the remote is reset or removed from the network

## Removing Intelligent Lighting From Your Remote

**Step 1:** Set receiving device to Find and Bind mode. Lights will flash indicating Find and Bind mode active: Duration 3 minutes.

**Step 2:** Bring remote within 10cm of the Intelligent Lighting Device. 3 Minutes until timeout.

**Step 3:** Short press the group button that the device was linked to.

**Step 4:** Press and Hold power button until LED indicator turns on.

**Step 5:** Quickly short press C5W button **twice**. LED indicator will flash. 20 Seconds until timeout. LED indicator blinks x6 for successful unpairing.

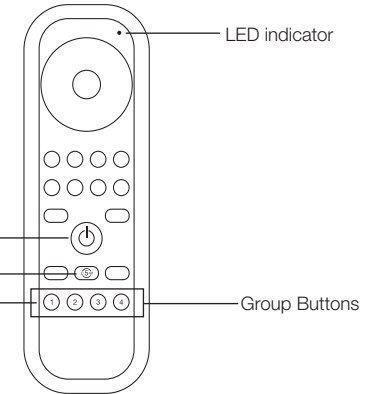

## How To Save And Recall Scenes

**Step 1:** Make sure that lighting devices have already been paired to the 4 groups that you would like to save scenes for.

**Step 2:** Choose the groups that you want to create a scene for. Red indicators will light up under the group buttons when the group is selected.

**Step 3:** Press and hold down a scene button (e.g. S1-S7) to save the settings.

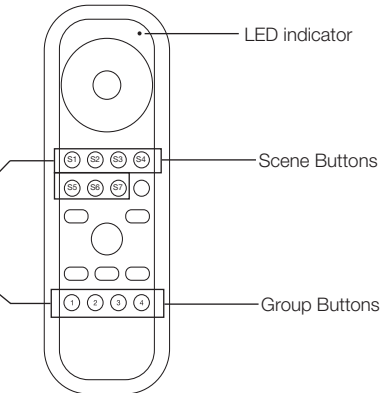

### Recall The Saved Scenes

**Step 1:** Short press button S1-S7 to recall a saved scene for each individual group at the same time.