

Safety

- Do not cover the ground contact.
- Do not place any material over the lens or LED diode/chip.
- Do not insert objects into the luminaire.
- Do not clean using any solvent based abrasive or aggressive product.
- Do not pull any cables connected to the product.
- Do not direct the luminaire into a person's eyes, as this unit may have an intense light output, which if incorrectly used may cause eye damage.
- Light engines/LED'S and other light sources may heat up, please take care when handling the products.
- The manufacturer will not be deemed liable or held responsible for any damages caused by faults or manufacturing defects that may be present in any of its products or the misuse or incorrect installation of this device.
- The manufacturer will not be held liable for any death(s) or injuries caused by misuse or poor installation or any unreported faults of this product version or versions thereof.
- LED's are sensitive to electrostatic discharge. Do not touch the surface of any LED module.
- Do not connect to a temporary electricity supply, this may damage any electronics.
- Light fittings with an integrated emergency option are with a separate installation and wiring leaflet. Please refer to this manual for further details. If the manual is unavailable please contact an All LED representative for assistance.

Returns & Faulty Items

- If any problem is encountered during or after installation, please call All LED technical department to get the problem resolved.
- Please do not just return the item to the outlet you purchased it from, as you are only entitled to a replacement or refund after the unit has undergone testing and the unit has been confirmed as having a manufacturing defect/fault. Your statutory rights are not affected.
- The manufacturer will not be deemed liable or held responsible for any damages caused by faults or manufacturing defects that may be present in any of its products or the misuse or incorrect installation of this device. Please refer to our trouble shooting guide for further information.
- All goods are supplied under the terms and conditions of All LED Ltd, a copy of which may be obtained upon written request.



INSTALLATION GUIDE AWL12**/CCT

Morph 11W CCT Decorative Bi-Directional Wall Luminaire



WARNING

- This product must be installed by a qualified electrical installer.
- All electrical work should be completed in accordance with the latest IET regulations, or any other relevant rules, regulations or laws of the country in which it is being installed.
- Ensure the item is isolated from any form of insulation and is adequately ventilated to prevent premature decay of any LED package that may be installed in it.
- Ensure power supply is isolated prior to installation, maintenance or performing any other form of electrical work.
- The company MUST be contacted immediately for advice or swift resolution of any matters concerning any of All LED's products.
- All LED Ltd is not responsible for LED lamps being damaged by excessive heat caused inside this fitting.
- All LED Ltd is not responsible for LED lamps being damaged due to poor isolation, or inadequate air circulation.

Technical Specifications

PRODUCT CODE	AWL12WH/CCT	AWL12BK/CCT
CCT (COLOUR TEMPERATURE)	3000K/4000K/6000K	3000K/4000K/6000K
RATED POWER	11W	11W
LUMENS	≤900lm	≤900lm
BEAM ANGLE	0 -120°	0 -120°
CRI	≤80	≤80
LIFETIME	25,000 hrs	25,000 hrs
AMBIENT OPERATING TEMPERATURE	-20~45°C	-20~45°C
IP RATING	IP65	IP65
OPERATING VOLTAGE	220-240V AC	220-240V AC
PF	>0.5	>0.5
FREQUENCY	50-60Hz	50-60Hz
GUARANTEE	3 Years	3 Years
SDCM	<6	<6
PEAK INTENSITY	200cd	200cd
SWITCHING CYCLES	≤15,000	≤15,000
STARTING TIME	Instant Full Light	Instant Full Light
CLASS	I	I



PLEASE READ
BEFORE USE!



ALL LED LTD
42 Sedgwick Road,
Luton, LU4 9DT

www.allledgroup.com
sales@allledgroup.com
Tel: +44 (0)208 841 9000

The manufacturer will not be deemed liable or held responsible for any damages caused by faults or manufacturing defects that may be present in any of its products or the misuse or incorrect installation of this device
Your statutory rights are not affected.



Environmental Protection
Waste electrical products should not be disposed of with household waste. Please recycle where facilities exist. Check with your Local Authority or retailer for recycling advice



ISOLATE MAINS SUPPLY
BEFORE HANDLING ANY
ELECTRICAL PRODUCTS

Installation Instructions

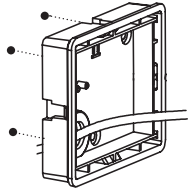
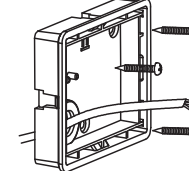
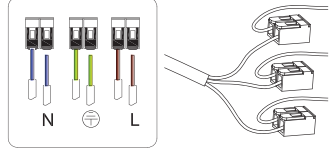
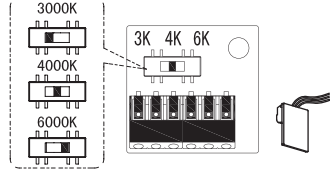
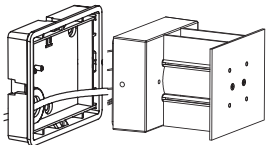
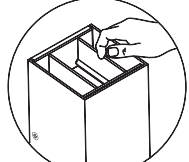
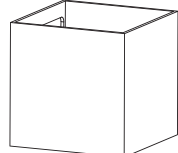
	<p>1. Hold the backbox against the surface and mark two holes to be drilled using the appropriate method</p>
	<p>2. Feed the cable through the back box and secure the box to the wall using screws provided</p>
	<p>3. Connect the wires to the fixture using Wago® Connectors</p>
	<p>4. Select the colour temperature using the CCT switch</p>
	<p>5. Secure the fixture on to the back box using the stub screws</p>
	<p>6. Manually adjust the beam angle for the lights as preferred</p>
	<p>7. Add the top cover and tighten the screws on the side</p>

Dimensions

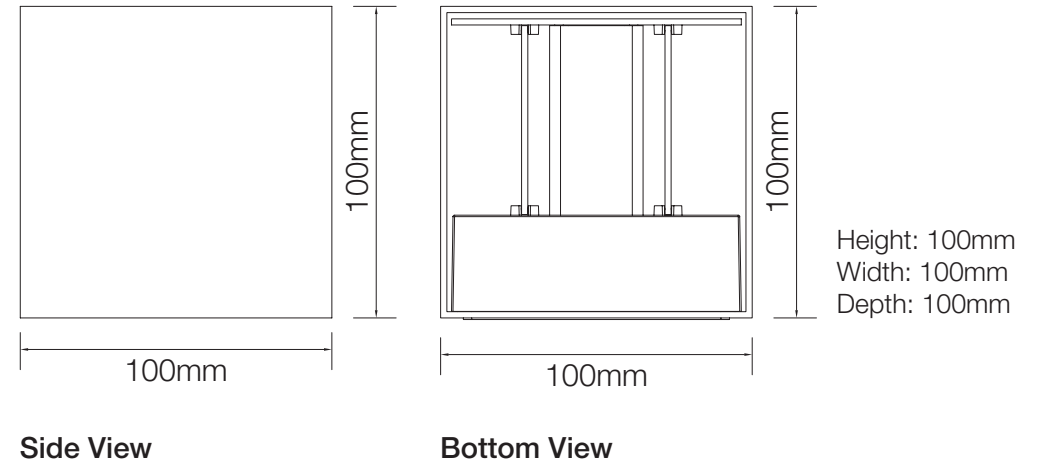

Trouble Shooting Guide

PROBLEM	CAUSE(S)	SOLUTION(S)
No light output from LED's	No power to luminaire holder components.	A qualified installer/electrician should check the Primary voltage side of the product to check the input voltage.
	Loose connection on primary side.	Continuous and correct connection between terminals.



ATTENTION
IF ANY PROBLEMS PERSIST, PLEASE CALL THE ALL LED TECHNICAL DEPARTMENT FOR FURTHER ASSISTANCE.