

ADRCV1215

15W 12V DC
Constant Voltage LED Driver

Drive12

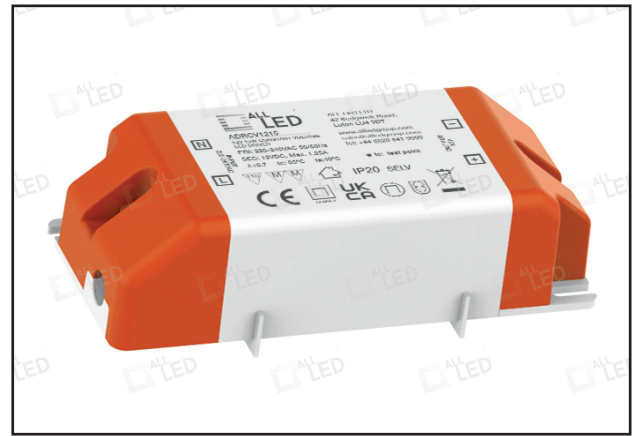

PRODUCT FEATURES

- 12V Constant Voltage LED Power Supply
- Over Temperature Protection
- Overload Protection
- No Load Protection
- Regulated Output
- SELV Rated

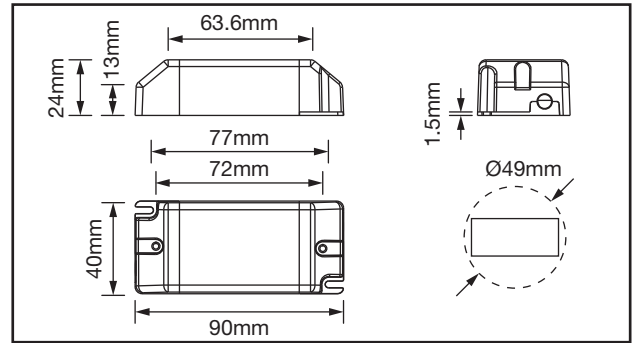

TECHNICAL SPECIFICATIONS

PRODUCT CODE	ADRCV1215
Operating Voltage	220-240V
Operating Current (A Max)	0.2A
Max Output Power	0 - 15W
Output Current (Max)	1.25A
Output Voltage	12Vdc
Power Factor	>0.7
Efficiency %	78%
No Load Power (W)	<0.5W
Dimmable	No
Class	II
Body Material	Polymer
Frame Colour	White (Orange Caps)
Switching Cycles	>100,000
Ingress Protection	IP20
Ambient Operating Temperature (°C)	-20°C ~ +50°C
Input Frequency (Hz)	50/60Hz
Guarantee	3 Years
Lifetime	30,000 Hrs
Displacement Factor	>0.7
Inrush Current	20A, 0.1µs
Over Temperature Protection	Yes
Overload Protection	Yes
No Load Protection	Yes

