

ADRCV24100TD

100W 24V Constant Voltage
Triac Dimmable LED Driver

PRODUCT FEATURES

- Compatible With Trailing & Leading Edge Dimmers
- Tough Polycarbonate Body
- Loop-In - Loop-Out Design
- Large Terminals
- Overload Protection
- No Load Protection
- Short Circuit Protection
- Thermal Protection
- Overcurrent Protection

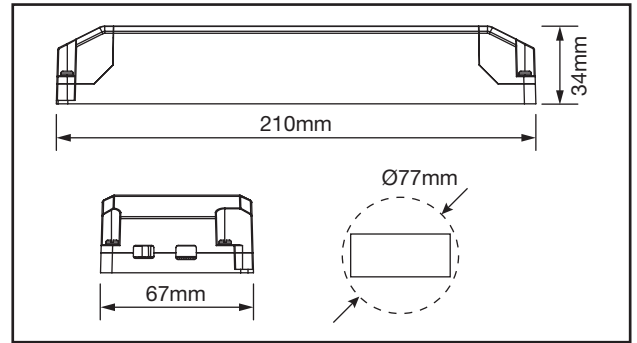
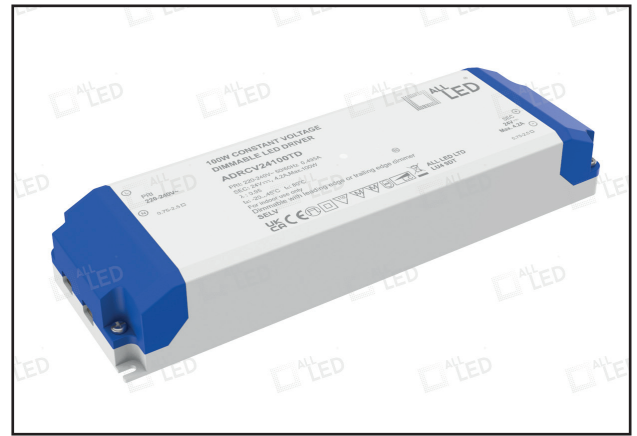

TECHNICAL SPECIFICATIONS

PRODUCT CODE	ADRCV24100TD
Operating Voltage	220-240VAC
Operating Current (A max)	0.495
Max Output Power	5 - 100W
Output Current (Max)	4.2A
Output Voltage	24Vdc
Power Factor	0.95
Efficiency %	88%
No Load Power (W)	<0.5W
Class	II
Body Material	Polycarbonate
Frame Colour	White
Switching Cycles	100,000
Ingress Protection	IP20
Ambient Operating Temperature (°C)	-20°C ~ +45°C
Input Frequency (Hz)	50-60Hz
Guarantee	3 Years
Dimmable	Yes
Dimming Mode (Trailing or Leading)	Trailing & Leading
Output Type	Constant Voltage
Lifetime	50,000 Hrs
Start Up Time	<0.5s
Inrush Current A pk (TH & ms)	20 (th=100µs)

