

ADRCV24SL/200IP

Drive24HP 200W IP67 High Power 24V
DC Constant Voltage LED Driver

Drive24

PRODUCT FEATURES

- 24V DC Output
- Pre-Wired Unit
- Fully Insulated IP67 Rated
- Compact Slimline Design
- Enclosed Extruded Aluminium Housing
- Pre-Flexed With Toughened Rubber Cables
- High Efficiency
- SELV, Short Circuit, Overload, Over-Voltage, Over-Current And Thermal Protection
- Load De-Rating Not Required

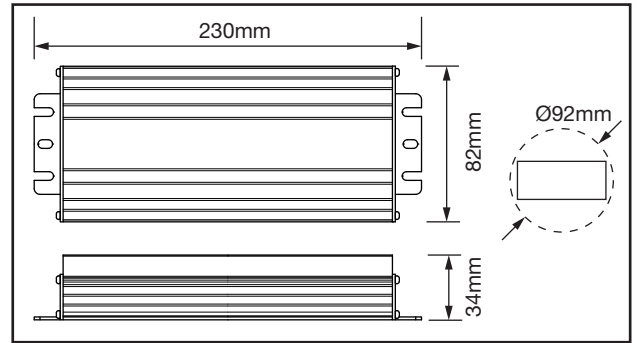

TECHNICAL SPECIFICATIONS

PRODUCT CODE	ADRCV24SL/200IP
Operating Voltage	100-240Vac
Operating Current (A max)/AC Current (Max)	0.95A
Max Output Power	0 - 200W
Output Current (max)	8.3A
Output Voltage	24Vdc
Power Factor	>0.94
Input Frequency (Hz)	50-60Hz
Efficiency %	92%
No Load Power (W)	<0.5W
Dimmable	Non Dimmable
Class	I
Body Material	Aluminium Housing
Frame Colour	Silver Colour
Ingress Protection	IP67
Ambient Operating Temperature (°C)	-20°C ~ +50° C
Guarantee	5 Years
Output Type	Constant Voltage

