

Safety

- Do not cover the ground contact.
- Do not cover the item, hang or fasten anything from it.
- Do not operate if any visible damage can be seen to the product.
- Do not operate if any water ingress has occurred.
- Do not operate if any smoke, steam or crackling noises can be heard from the item.
- Do not operate if any signs of overheating are recognised.
- Avoid installation in any areas where there is a risk of strong mechanical loads.
- Do not place any material over the item.
- Do not insert objects into the item.
- Do not clean using any solvent based abrasive or aggressive product.
- Do not pull any cables connected to the product.
- Light engines/LEDs, other light sources and lighting products may heat up, please take care when handling the products.
- The manufacturer will not be deemed liable or held responsible for any damages caused by faults or manufacturing defects that may be present in any of its products or the misuse or incorrect installation of this device. Please refer to our troubleshooting guide for further information.
- The manufacturer will not be held liable for any death(s) or injuries caused by misuse or poor installation or any unreported faults of this product version or versions thereof.
- Do not connect to a temporary electricity supply, this may damage the electronics.
- Isolate the item from direct, strong sunlight.
- Keep away from children.

Returns & Faulty Items

- If any problem is encountered during or after installation, please call the ALL LED technical department to get the problem resolved as soon as possible.
- Please do not just return the item to the outlet you purchased it from, as you are only entitled to a replacement or refund after the unit has undergone testing and the unit has been confirmed as having a manufacturing defect/fault. Your statutory rights are not affected.
- The manufacturer will not be deemed liable or held responsible for any damages caused by faults or manufacturing defects that may be present in any of its products or the misuse or incorrect installation of this device. Please refer to our trouble shooting guide for further information.
- All goods are supplied under the terms and conditions of ALL LED LTD, a copy of which may be obtained upon written request.



INSTALLATION GUIDE & USER MANUAL ADRCV24100TD



ENSURE POWER SUPPLY IS OFF WHEN HANDLING ANY ELECTRICAL EQUIPMENT.

- This product may need to be installed by a qualified electrical installer.
- Please read this guide in its entirety to fully understand the products before attempting any install.
- All electrical work should be completed in accordance with the latest IET regulations, and/or any other relevant rules, regulations or laws of the country in which it is being installed.
- The item must be installed in isolation from any insulating material and is adequately ventilated to prevent premature failure.
- Ensure power supply is isolated prior to installation, maintenance or performing any other form of electrical work.
- The company **MUST** be contacted immediately for advice or swift resolution of any matters concerning any of ALL LED's products.

Technical Specifications

Product Code	ADRCV24100TD
Operating Voltage	220-240VAC
Operating Current (A max)	0.495
Max Output Power	100W
Output Current (Max)	4.2A
Output Voltage (Max)	24V
PF	0.95
Efficiency %	88
No Load Power (W)	<0.5W
Class	II
Body Material	Polycarbonate
Frame Colour	White
Switching cycles	100,000
Ingress Protection	IP20
Ambient Operating Temperature (°C)	-20°C ~ +45°C
Input Frequency (Hz)	50-60Hz
Guarantee	3 Years
Dimmable	Yes
Dimming Mode (Trailing or Leading)	Trailing & Leading
Output type	Constant Voltage
Life Time	50,000 hours
Start Up Time	<0.5s
Inrush Current A pk (TH & ms)	20 (th=100µs)



ALL LED LTD
42 Sedgwick Road,
Luton, LU4 9DT

www.allledgroup.com
sales@allledgroup.com
Tel: +44 (0)208 841 9000



Environmental Protection
Waste electrical products should
not be disposed of with household
waste. Please recycle where
facilities exist. Check with your
Local Authority or retailer for
recycling advice

The manufacturer will not be deemed liable or held responsible for any damages caused by faults or manufacturing defects that may be present in any of its products or the misuse or incorrect installation of this device
Your statutory rights are not affected.



Installation Instructions

1. We recommend checking the installation with the products for suitability prior to installation.
2. Turn off power supply at source to avoid any risk of electric shock.
3. Locate where the LED driver is to be installed.
4. Affix the LED driver to the surface/area using the appropriate method according to the substrate of the base material.
5. Connect the DC output side of the LED driver to the luminaire using the diagram below for reference purposes. Ensure the correct polarity.
6. Connect the AC input of the LED driver to the relevant electrical circuit,
7. Double check the connections and the overall installation. Turn the power supply on and check the item is functioning as it should.
8. Turn the power supply on and check the item is functioning as it should.

Dimensions

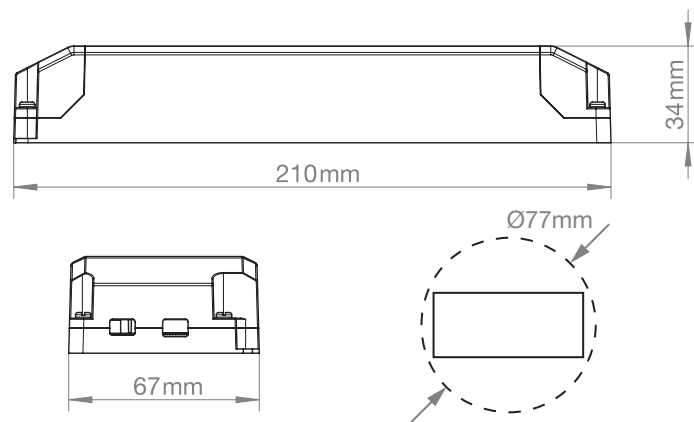

Notes

- Should you encounter any difficulties, please refer to the troubleshooting guide on the opposite page.
- Should you encounter any further difficulties with this product, please contact the ALL LED technical team.
- Should this product cease working, a replacement drive unit will be dispatched to try to solve the issue.
- Do not hold this product from any trailing leads, it may damage the integrity of the product.
- THIS UNIT MAY HOLD SOME RESIDUAL DISCHARGE, PLEASE LEAVE DISCONNECTED AT MAINS FOR A MINIMUM OF 24 HOURS BEFORE HANDLING ANY ELECTRICAL COMPONENTS ON THIS ITEM.
- This item is CONSTANT VOLTAGE and requires PARALLEL wiring on the DC side.

Troubleshooting Guide

PROBLEM	CAUSE(S)	SOLUTION(S)
No Light Output From LEDs	No power to drive components	A qualified installer/electrician should check the Primary voltage side of the product to check the input voltage.
	Loose connection on primary side.	Ensure continuous and correct connection between terminals.
	Loose connection on secondary side.	Ensure continuous and correct connection between terminals. Ensure the polarity is correct; (Red = +, Black = -).
	No output from the driver.	Driver may be faulty and require replacement. Please order a replacement via your local outlet. Product codes are listed on the specification table on the first page.
	Overvoltage may have caused damage to the sensitive LED components.	These cases are rare and the item may need replacement and/or investigation as to the cause of failure.
LEDs Flashing	Unstable or incorrect input voltage.	Please only use a stable voltage supply as stipulated earlier for this product. Failure to do so will void the warranty.
	LED driver may be connected to a dimmer switch	Please remove the dimmer switch. Use of this product on a dimmer will void the warranty. This product is supplied non-dimmable as standard.
	Loose connection on primary side.	Ensure continuous and correct connection between the terminals.
	Loose connection on secondary side.	Ensure continuous and correct connection between terminals. Ensure the polarity is correct; (Red = +, Black = -).
	Wattage overload	Too much power is trying to be drawn from the item. Flashing indicates the overload protection is actively working to prevent any damage to the item. Reduce the load on the DC side of the item.



ATTENTION

IF ANY PROBLEMS PERSIST, PLEASE CALL THE ALL LED TECHNICAL DEPARTMENT FOR FURTHER ASSISTANCE.